

MONA 3

WQJP05030

LED luminaire MONA 3, with a power of 27 W, high light efficacy 125 lm/W. It is made of high-quality components, supported by a 5-year warranty. It also stands out for its very high colour rendering index RA>90. Lights up with neutral light - the most universal colour (4000K), which is suitable for the rooms we use on a daily basis, ensuring comfort during everyday activities. Narrow beam angle 15° gives directional light so that selected objects or surfaces can be better exposed. Designed for recessed mounting.



Power	27 W	Voltage	230 V
Colour temperature	4000 K	Colour of light	Neutral white
Beam angle	15 °	Degree of protection (IP)	IP20

Technical data

Code	WQJP05030
Power	27 W
Nominal current	129.1 mA
Voltage	230 V
Energy consumption	27 kWh/1000h
Frequency	50HZ Hz
Protection class	II
Power supply included	+
Manufacturer of power supply	TCI
Power factor	0.93
Useful luminous flux*	3375 lm (360°)
Luminous flux**	2700 lm (360°)
Lamp efficacy	125 lm/W
Colour temperature	4000 K
Colour of light	Neutral white
Beam angle	15 °
RA	90
Light source included	+
Producer of LED diodes	CREE
Uniformity of color SDCM max	3
Dimmable	OPC
Working temperature range	-20/+40 °
Lifespan	50000 h
Housing material	Aluminum
Degree of protection (IP)	IP20
Colour	White
Dimension (AxBxC)	180x130 mm
Mounting hole	Ø145 mm
For use	Inside
Assembly method	Recessed
Application	Inside
Made in	PL

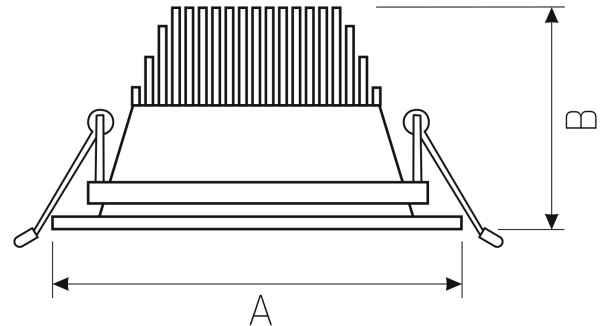

Related documents



 Photometric file



 3D model